

Ruby 050

Construction materials: **Aluminum - AISI 316**

New pump line with a brand new designing that offers reinforced pumping potentials. The updated designing provides even bigger performance provided with economy.

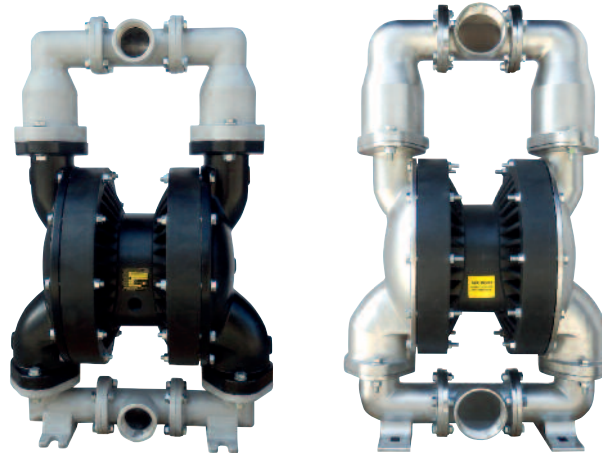

Benefits

- Optimal performance
- Economical air consumption, ecological designing
- High efficiency for pressure/capacity
- Oil free operation
- No freezing
- New air valve designing, fully controlled air passing
- Easy disassembling and re-assembling
- New generation diaphragms with embodied inner-outer piston
- New generation PTFE diaphragms of embodied type for long-life operation (compound)
- Advanced quality Full capacity PTFE-A diaphragms for high chemical and mechanical applications
- Potential to be submersible (on request)
- Possibility to be used in dirty environments due to their closed designing
- Easy manifold reverse
- Automatic suction

Ruby 050 composition codes

Pump model	Body	Center block	Diaphragms	Valve Seats	Balls	O-ring	Other options
Ruby 050	A: Aluminum S: AISI 316 SL: AISI 316 Electropolished	P: PP PC: PP+CF W: PP FDA	N: NBR Conductive E: EPDM Conductive T: TFM+(EPDM Conductive) Z: TFM-A+(EPDM Conductive)	N: NBR E: EPDM A: Aluminum S: AISI 316	N: NBR E: EPDM T: PTFE S: AISI 316	N: NBR F: FKM T: PTFE E: EPDM	D: Twin Manifold F: Flange PN10/ANSI/JIS

Ruby Innovative oil free air valve

The heart of the Ruby pump is our innovative, new design air valve. In respect for New Era demands, to create and offer High Quality product, with high interest for the environment and it's protection, the Air Valve of the Ruby Diaphragm Pumps has been created to offer:

- ✓ Oil free operation
- ✓ Low need for maintenance
- ✓ Not affected by minor contamination of compressed air
- ✓ Significant energy saving
- ✓ Non freezing operation
- ✓ External environment operation
- ✓ No dead centre
- ✓ Long life
- ✓ Reliability

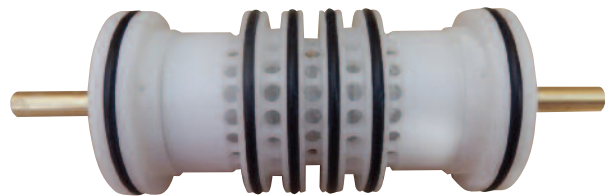

Advance unified diaphragms featuring:

- ✓ Easy installation and maintenance
- ✓ Excellent service life
- ✓ Inventory cost reduction
- ✓ Improved performance
- ✓ Greater displacement per cycle
- ✓ No center hole, elimination of potential leak paths.
- ✓ There is no need for the main axis to be insured
- ✓ They can be screwed and unscrewed without the use of tools



Advance Unified Diaphragm offers:

The prominences decrease the stretching of the PTFE during the regression and prevent it from cracking.

Innovative conical shape ideal for optimal performance and life, low pressure requirements for start-up, ideal suction

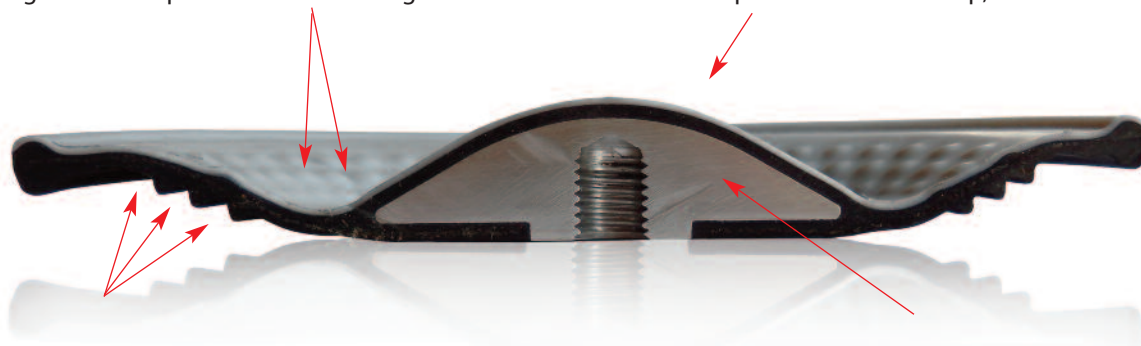

Innovative diaphragm support side, offers flexibility, long life and protects from cavitation

Special internal plate supports your diaphragm in every movement

Technical data

ATEX certification	II 2 GD c IIB T4 135°C
Construction materials	ALUMINIUM, AISI 316
Diaphragms	NBR Conductive EPDM Conductive Compound PTFE+Back up EPDM Conductive Compound PTFE A+Back up EPDM Conductive
Intake/delivery connections	2" BSP G - Flange on Request
Air connection	3/4"
*Max. self-priming capacity	5 m
*Max. flow rate	696 l/min
Max. head	70 m
Max. air supply pressure	7 bar
Diameter	8 mm
Max. operating temp.	95°C
Weight Aluminium	50 kg
Weight AISI 316	70 Kg

* The curves and performance values refer to pumps with submerged suction and a free delivery outlet with water at 20°C, and vary according to the construction material.

Performance

RUBY 050 - FULL CAPACITY PTFE - A FITTED

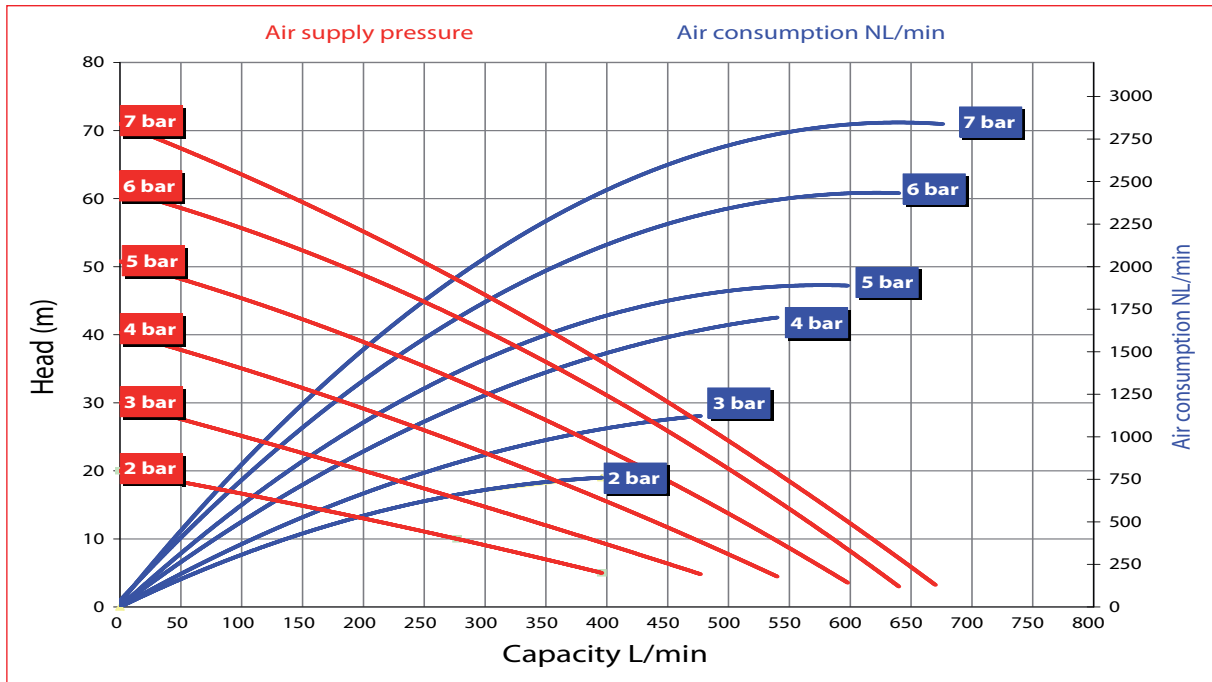

RUBY 050 - RUBBER FITTED

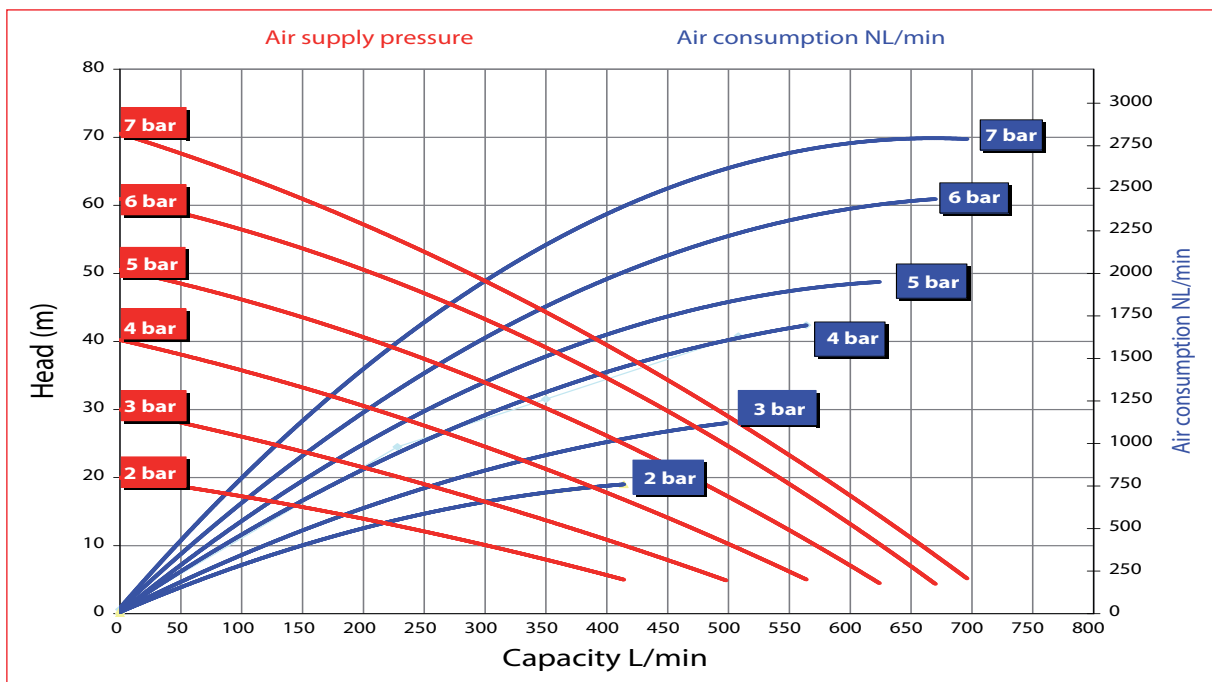

Performance

RUBY 050 - PTFE FITTED

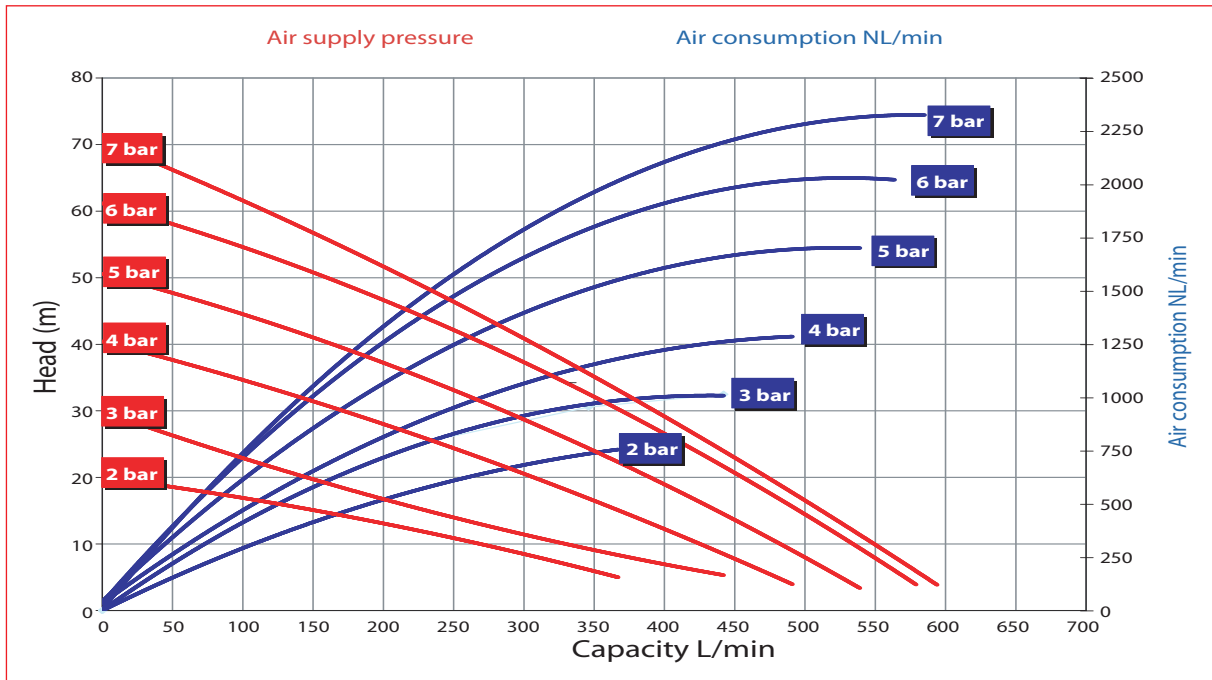

Dimensions Ruby 050 Metallic Pump

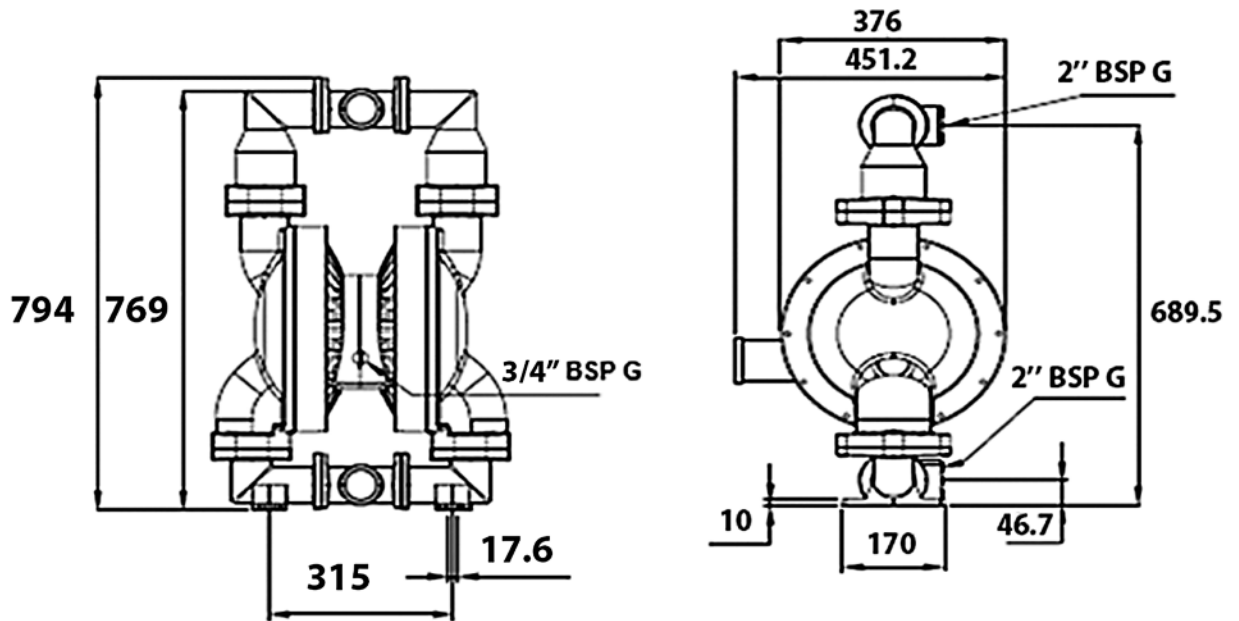

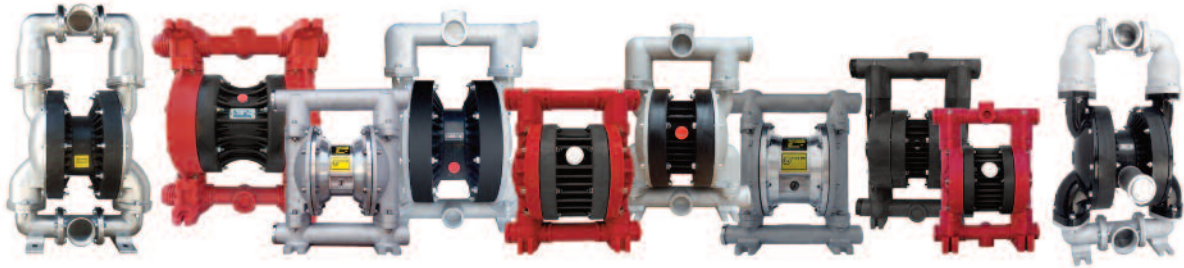

ALPHADYNAMIC PUMPS Co

England Sales office:

Rockleigh House, 37 Burton Road
Ashby de la Zouch, Leicestershire
LE65 2LF - United Kingdom (UK)
Registered in ENGLAND & WALES
Registration number 09706219 - VAT No.GB220393343
Tel +44 1213 680 324, +44 1213 680472
email:sales@alphadynamicpumps.co.uk
www.alphadynamicpumps.co.uk

Hellas Production Facilities Unit 1

3 Eleftherias Str Industrial Park of Kifisia
14564 - Kifisia - Hellas
VAT No. EL 999695309
Tel +30 210 4200 338, +30 210 4200 422
Fax +30 211 268 68 37
email: info@alphadynamic.eu
www.alphadynamic.eu

Hellas Production Facilities Unit 2

30 Seneka str Industrial Park of Kifisia
14564 - Kifisia - Greece
Tel +30 215 215 9152
email: sales@rubypump.com